

8

7

6

5

4

3

2

1

A

A

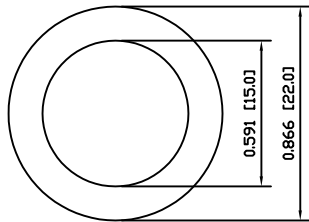

COLORS AND FINISH

BEZEL:
Stainless Steel

ACTUATOR:
Stainless Steel

SCHEMATIC

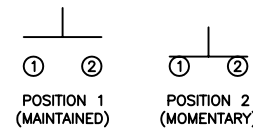

SPECIFICATIONS

FUNCTION:
1P1T OFF-(ON)

RATING:
2A 48VDC

CONTACT RESISTANCE:
Initial: 50mΩ Max. at 1A 12VDC

INSULATION RESISTANCE:
1,000MΩ Min. at 500VDC

DIELECTRIC STRENGTH:
2,000VAC Min. for 1 Minute

ELECTRICAL LIFE:
200,000 Cycles Min.

MECHANICAL LIFE:
1,000,000 Cycles Min.

INTRUSION PROTECTION:
IP65

TEMPERATURE:
Operating: -20°C to 70°C

APPROVALS:

RoHS

MATERIALS

BUSHING:
Stainless Steel

BASE:
Polybutylene Terephthalate (PBT), UL94 V-2

ACTUATOR:
Stainless Steel
Brass (H59)

HARDWARE:
Nickel Plated Brass (H59)

SEALING:
Silicone
Stainless Steel

INNER ASSEMBLY:
Polyamide 6/6 (PA66)
Brass (H59)

SPRING:
Steel (Cr18Ni9)

CONTACTS:
Silver Plated Copper

TERMINALS:
Silver Plated Brass (H59)
Steel (A3)

B

B

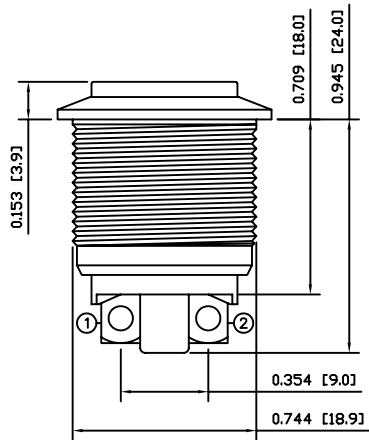

POSITION 1 —
POSITION 2 —

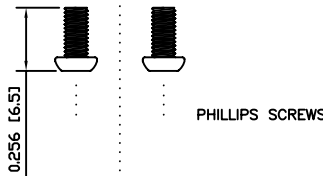
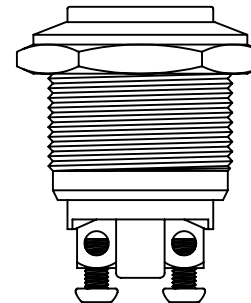
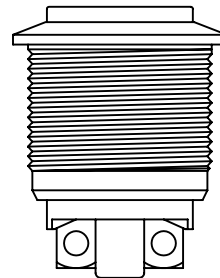
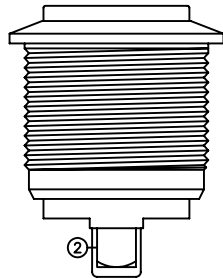

PHILLIPS SCREWS

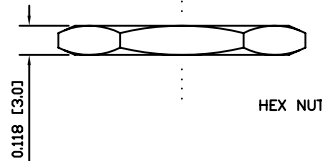

HEX NUT

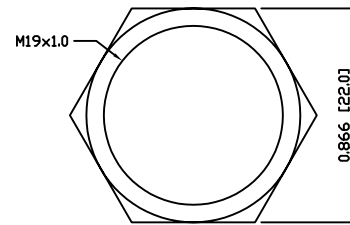

ASSEMBLED VIEW

EXPLODED VIEW

SUGGESTED PANEL CUTOUT

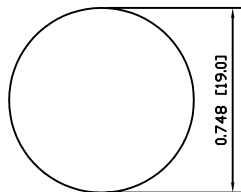

MAXIMUM PANEL THICKNESS: 0.315 [8.0mm]

D

D



P.O. Box 25110
Portland, OR 97298

LAST REVISION:
SEPT. 13, 2007

DRAWING NUMBER: 52-PV1H640SS.dwg

UNLESS OTHERWISE SPECIFIED,
DIMENSIONS ARE IN INCHES [MILLIMETERS]
TOLERANCES ARE:

DEC .X±0.2	ANG ± 1°
.XXX±0.008	DRAWING NOT TO SCALE
DRAWN BY: CARL BUCHHEIT	

PV1H640SS

8

7

6

5

4

3

2

1