

8

7

6

5

4

3

2

1

A

A

COLORS AND FINISH

BEZEL:  
Bright Nickel

ACTUATOR:  
Bright Nickel

ILLUMINATION:  
Red

SCHEMATIC

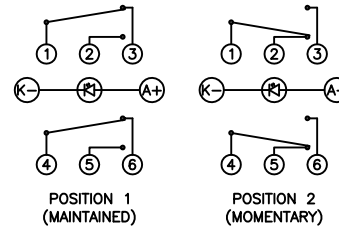

SPECIFICATIONS

FUNCTION:  
2P2T ON-(ON)

RATING:  
2A 48VDC

ILLUMINATION VOLTAGE:  
12V

CONTACT RESISTANCE:  
Initial: 50mΩ Max. at 1A 12VDC

INSULATION RESISTANCE:  
1,000MΩ Min. at 500VDC

DIELECTRIC STRENGTH:  
2,000VAC Min. for 1 Minute

ELECTRICAL LIFE:  
50,000 Cycles

MECHANICAL LIFE:  
1,000,000 Cycles

TEMPERATURE:  
Operating: -20°C to 70°C

APPROVALS:

**RoHS**

MATERIALS

BUSHING:  
Nickel Plated Brass (H62)

BASE:  
Polybutylene Terephthalate (PBT), UL94 V-2  
Polycarbonate (PC), UL94 V-2

ACTUATOR:  
Nickel Plated Brass (H62)

ILLUMINATION LENS:  
Polycarbonate (PC), UL94 V-2

HARDWARE:  
Nickel Plated Brass (H62)

INNER ASSEMBLY:  
Polyoxymethylene (POM), UL94 HB  
Polycarbonate (PC), UL94 V-2  
Brass (H62)

SPRING:  
Phosphor Bronze

MOBILE CONTACT:  
Phosphor Bronze

CONTACTS:  
Nickel-Silver (AgNi10)

TERMINALS:  
Silver Plated Brass (H62)

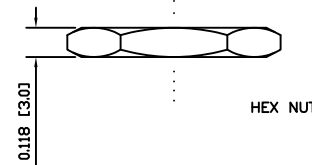
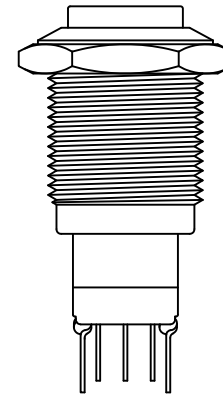
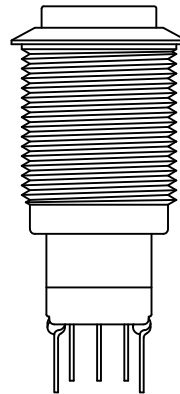
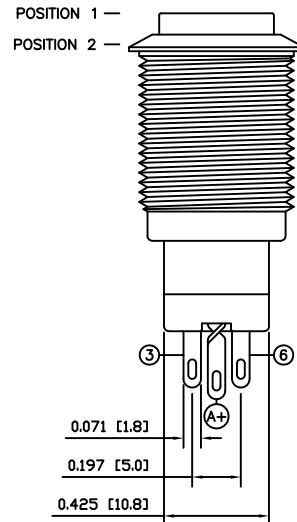
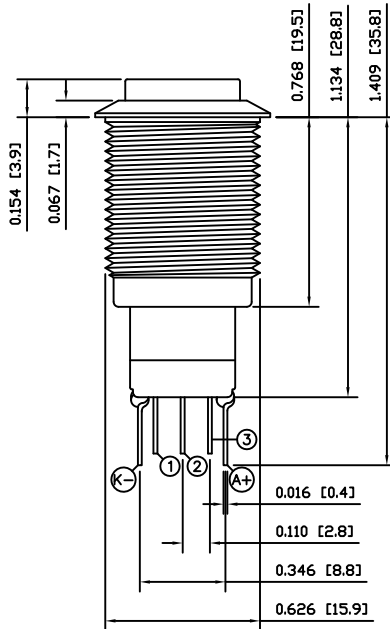
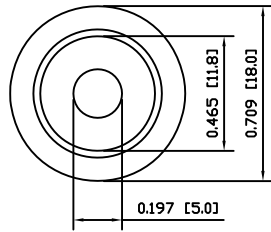

HEX NUT

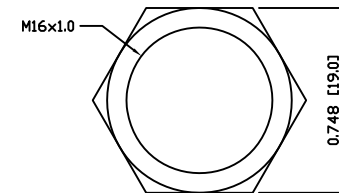

ASSEMBLED VIEW

EXPLODED VIEW

SUGGESTED PANEL CUTOUT

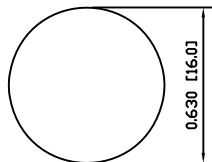

MAXIMUM PANEL THICKNESS: 0.551 [14.0mm]

UNLESS OTHERWISE SPECIFIED, DIMENSIONS ARE IN INCHES [MILLIMETERS] TOLERANCES ARE:	
DEC .X±0.2	ANG ± 1°
.XXX±0.008	DRAWING NOT TO SCALE
DRAWN BY: STACEY CHRISTIANSON	

**LAMB**  
INDUSTRIES P.O. Box 25110  
Portland, OR 97298

LAST REVISION:  
MAR. 11, 2008

DRAWING NUMBER: 52-PV3H2HONN-214.dwg

PV3H2HONN-214

8

7

6

5

4

3

2

1

D

D