

8

7

6

5

4

3

2

1

A

A

COLORS AND FINISH

BEZEL:  
Bright Nickel  
ACTUATOR:  
Bright Nickel  
ILLUMINATION:  
Red

SCHEMATIC

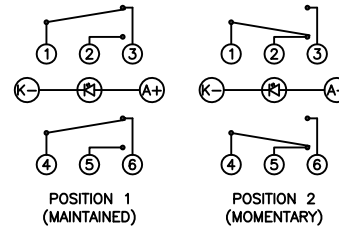

SPECIFICATIONS

FUNCTION:  
2P2T ON-(ON)  
RATING:  
2A 48VDC  
ILLUMINATION VOLTAGE:  
12V  
CONTACT RESISTANCE:  
Initial: 50mΩ Max. at 1A 12VDC  
INSULATION RESISTANCE:  
1,000MΩ Min. at 500VDC  
DIELECTRIC STRENGTH:  
2,000VAC Min. for 1 Minute  
ELECTRICAL LIFE:  
50,000 Cycles  
MECHANICAL LIFE:  
1,000,000 Cycles  
TEMPERATURE:  
Operating: -20°C to 70°C  
APPROVALS:

**RoHS**

MATERIALS

BUSHING:  
Nickel Plated Brass (H62)  
BASE:  
Polybutylene Terephthalate (PBT), UL94 V-2  
Polycarbonate (PC), UL94 V-2  
ACTUATOR:  
Nickel Plated Brass (H62)  
ILLUMINATION LENS:  
Polycarbonate (PC), UL94 V-2  
HARDWARE:  
Nickel Plated Brass (H62)  
INNER ASSEMBLY:  
Polyoxymethylene (POM), UL94 HB  
Polycarbonate (PC), UL94 V-2  
Brass (H62)  
SPRING:  
Phosphor Bronze  
MOBILE CONTACT:  
Phosphor Bronze  
CONTACTS:  
Nickel-Silver (AgNi10)  
TERMINALS:  
Silver Plated Brass (H62)

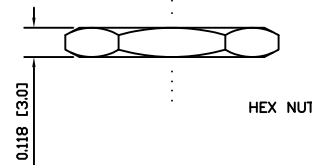
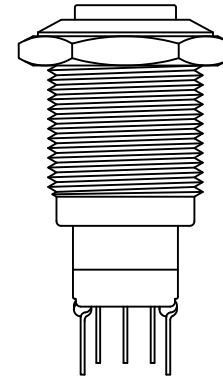
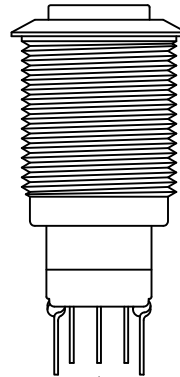
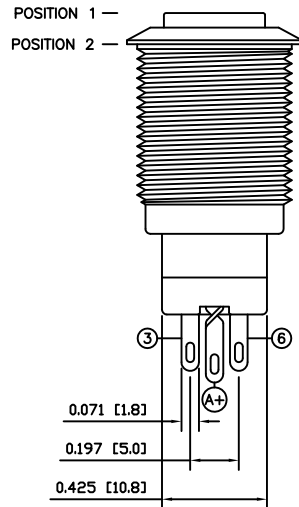
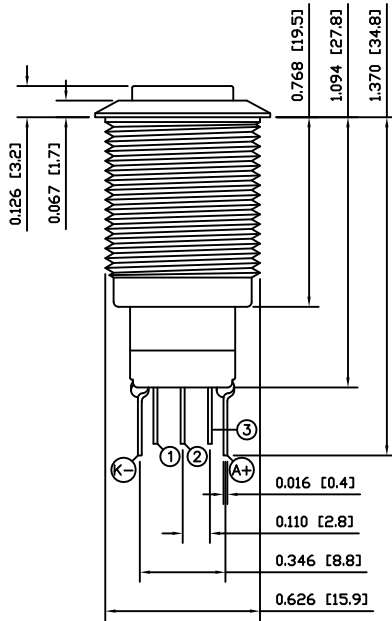
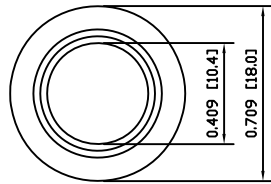

HEX NUT

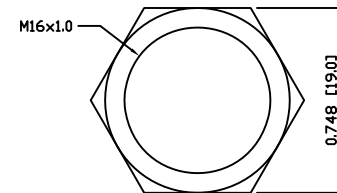

ASSEMBLED VIEW

SUGGESTED PANEL CUTOUT

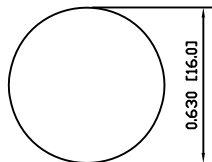

MAXIMUM PANEL THICKNESS: 0.551 [14.0mm]

UNLESS OTHERWISE SPECIFIED,  
DIMENSIONS ARE IN INCHES [MILLIMETERS]  
TOLERANCES ARE:  
DEC .X±0.2 ANG ± 1°  
.XXX±0.008 DRAWING NOT TO SCALE  
DRAWN BY: STACEY CHRISTIANSON



P.O. Box 25110  
Portland, OR 97298

LAST REVISION:  
MAR. 11, 2008

DRAWING NUMBER: 52-PV3H2HONN-314.dwg

PV3H2HONN-314

8

7

6

5

4

3

2

1

D

D