

8

7

6

5

4

3

2

1

A

A

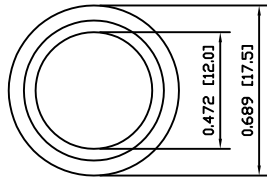

COLORS AND FINISH

BEZEL:
Black
ACTUATOR:
Black

SCHEMATIC

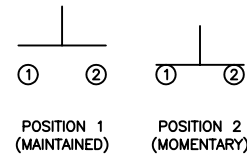

SPECIFICATIONS

FUNCTION:
1P1T OFF-(ON)
RATING:
2A 48VDC
CONTACT RESISTANCE:
Initial: 50mΩ Max. at 1A 12VDC
INSULATION RESISTANCE:
1,000MΩ Min. at 500VDC
DIELECTRIC STRENGTH:
2,000VAC Min. for 1 Minute
ELECTRICAL LIFE:
200,000 Cycles Min.
MECHANICAL LIFE:
1,000,000 Cycles Min.
INGRESS PROTECTION:
IP65
TEMPERATURE:
Operating: -20°C to 70°C

APPROVALS:

RoHS

B

B

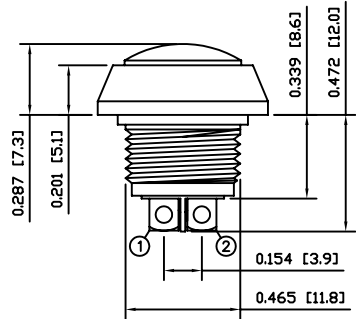

POSITION 1
POSITION 2

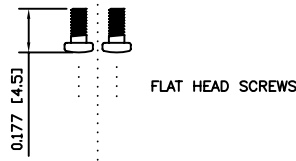
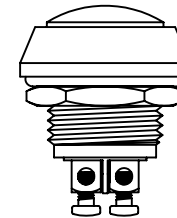
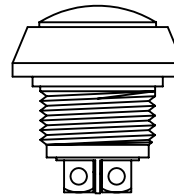
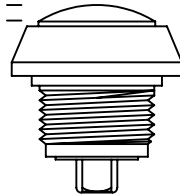

FLAT HEAD SCREWS

0.177 [4.5]

O-RING

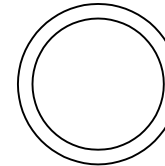

M12x1.0

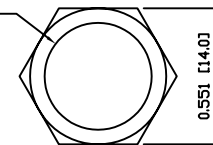

HEX NUT



0.079 [2.0]

EXPLODED VIEW

ASSEMBLED VIEW

C

C

SUGGESTED PANEL CUTOUT

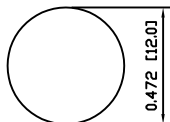

MAXIMUM PANEL THICKNESS: 0.138 [3.5mm]

D

D



P.O. Box 25110
Portland, OR 97298

LAST REVISION:
SEPT. 5, 2007

UNLESS OTHERWISE SPECIFIED,
DIMENSIONS ARE IN INCHES [MILLIMETERS]
TOLERANCES ARE:

DEC .X±0.2 ANG ± 1°

.XXX±0.008 DRAWING NOT TO SCALE

DRAWN BY: CARL BUCHHEIT

DRAWING NUMBER: 53-PV5S64011.dwg

PV5S64011

8

7

6

5

4

3

2

1